



HORNO BRASA JOSPER HJA-PLUS

JOSPER CHARCOAL BROILER OVEN HJA-PLUS

HJA-PLUS-M120-HCT

Los hornos de carbón vegetal Clase A incorporan un sistema hidráulico de retención de puerta para optimizar las maniobras del cocinero. Disponen de una area de templado superior que puede cerrarse con el accesorio disponible y una gama de mesas auxiliares opcionales.

Class A charcoal ovens incorporate a hydraulic door retention system to optimize the chef's maneuvers. They have an upper tempering area that can be closed with the available accessory and a range of optional auxiliary tables.

Recomendado para ± Recommended for ±	120 comensales 120 dinners
Tiempo de encendido Fire up time	35 min aprox. 35 min average
Consumo diario de carbón Charcoal daily consumption	12 a 16 kg 26.5 to 35 lb
Autonomía por carga Performance	9h
Producción por hora Production per hour	90 kg aprox. 192 lb average
Temperatura de braseado Broiling temperature	250 a 350 °C 482 a 662 °F
Capacidad bandejas GN (por parrilla) Grill rack capacity in Gn trays	2xGN1/1
Potencia térmica nominal Nominal heat output	7,4 kW 9.92 hp
Caudal másico de humos Flue gas mass flow	15,39 g/s 0.54 oz/s
Capacidad de extracción Exhaust rate	3500 m³/h 2060 cfm
Peso neto Net weight	-- kg -- lb



HJA-PLUS-M120-HCT

ACCESORIOS INCLUIDOS INCLUDED ACCESSORIES

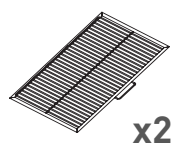

x2

Parrilla inox / Ref. [240025](#)
Inox grill rack / Ref. [240025](#)

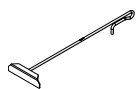

Atizador / Ref. [0427INOX](#)
Poker / Ref. [0427INOX](#)

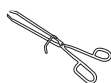

Pinzas Josper / Ref. [0423](#)
Josper tongs / Ref. [0423](#)

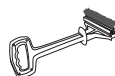

Cepillo metálico / Ref. [8224](#)
Metallic brush / Ref. [8224](#)

MEDIDAS PARRILLA GRILL RACK MEASUREMENTS

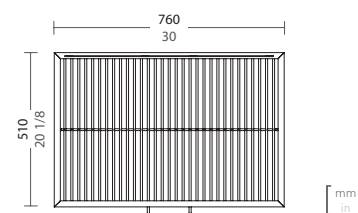

* Todos los productos Josper funcionan exclusivamente con carbón vegetal.
All Josper products work exclusively with charcoal.

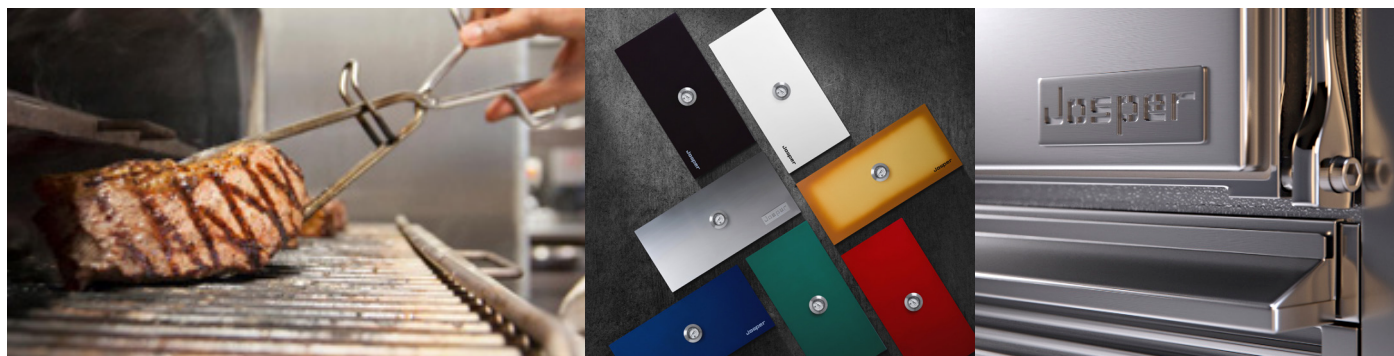

FT-C01150-05



HJA-PLUS-M120-HCT

INSTALACIÓN INSTALLATION

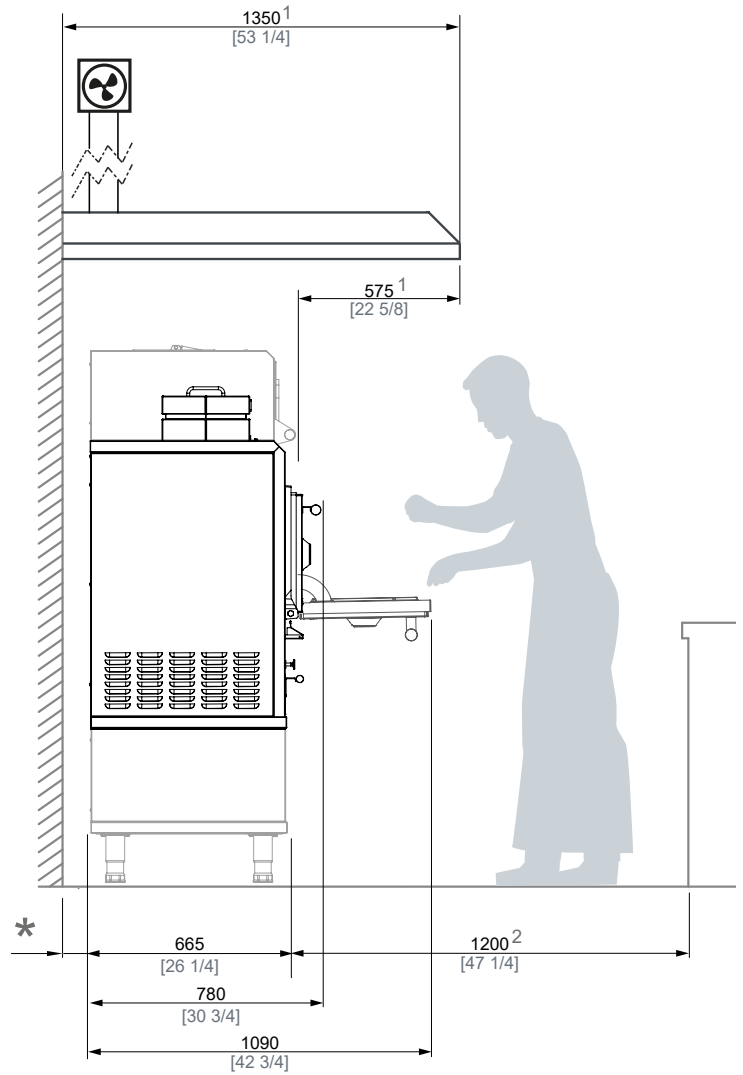
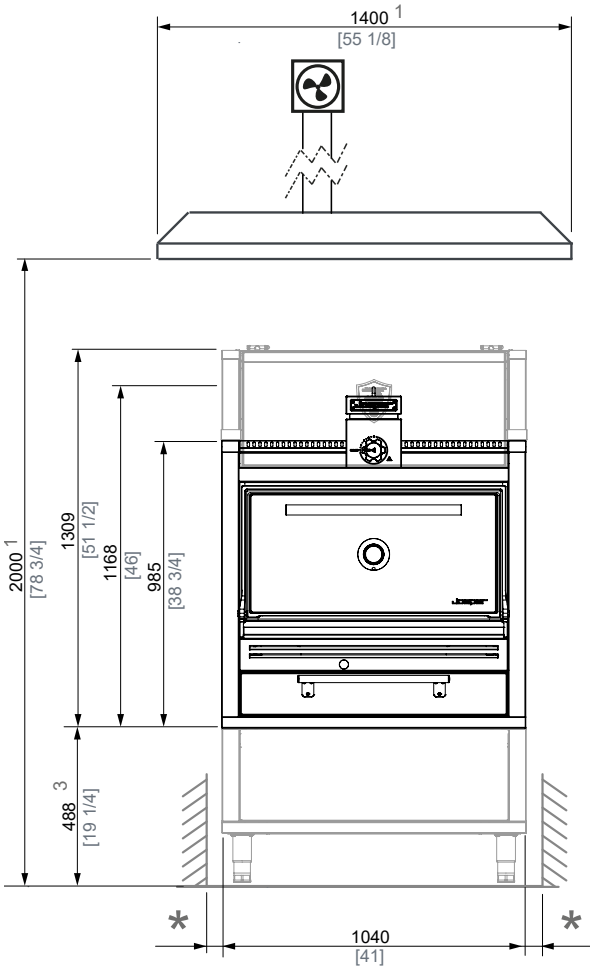

* DISTANCIA MÍNIMA A ELEMENTOS INFLAMABLES MINIMUM DISTANCE TO FLAMMABLE ELEMENTS	300 mm	12 in
* DISTANCIA MÍNIMA A ELEMENTOS NO INFLAMABLES MINIMUM DISTANCE TO FLAMMABLES ELEMENTS	100 mm	4 in

- 1 MEDIDAS MÍNIMAS RECOMENDADAS DE LA CAMPANA EXTRACTORA.
RECOMMENDED HOOD'S MINIMUM DIMENSIONS
- 2 ESPACIO RECOMENDADO DE TRABAJO PARA EL CHEF.
RECOMMENDED CHEF'S WORKING SPACE
- 3 ALTURA RECOMENDADA DE INSTALACIÓN DEL HORNO SIN MESA
RECOMMENDED HEIGHT TO INSTALL THE OVEN WITOUT TABLE

Ed. 07.2022 - Jospser se reserva el derecho a realizar modificaciones en los catálogos, tarifas y material de divulgación según evolución y mejora de sus equipos.
 Jospser reserves the right to make modifications to catalogues, pricelists and promotional material according to the development and improvements applied to its equipment.